



N-Channel JFETs

PRODUCT SUMMARY				
Part Number	V _{GS(off)} (V)	r _{DS(on)} Max (Ω)	I _{D(off)} Typ (pA)	t _{ON} Typ (ns)
2N5432	-4 to -10	5	10	2.5
2N5433	-3 to -9	7	10	2.5
2N5434	-1 to -4	10	10	2.5

FEATURES

- Low On-Resistance: 2N5432 <5 Ω
- Fast Switching—t_{ON}: 2.5 ns
- High Off-Isolation—I_{D(off)}: 10 pA
- Low Capacitance: 11 pF
- Low Insertion Loss

BENEFITS

- Low Error Voltage
- High-Speed Analog Circuit Performance
- Negligible “Off-Error,” Excellent Accuracy
- Good Frequency Response
- Eliminates Additional Buffering

APPLICATIONS

- Analog Switches
- Choppers
- Sample-and-Hold
- Normally “On” Switches
- Current Limiters

DESCRIPTION

The 2N5432/5433/5434 are suitable for high-performance analog switching and amplifier applications. Breakdown voltage characteristics, low on-resistance, and very fast switching make these devices ideal for a wide range of applications.

The hermetically-sealed TO-206AC (TO-52) package is suitable for processing per MIL-S-19500 (see Military Information). For similar products in TO-236 (SOT-23) or TO-226AA (TO-92) packages, see the J/SST108 series data sheet.

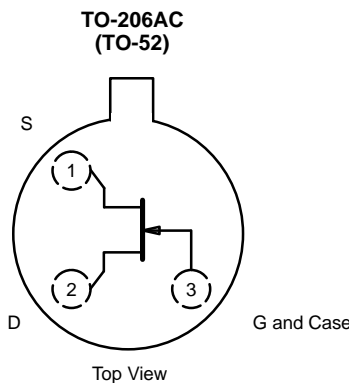

ABSOLUTE MAXIMUM RATINGS

Gate-Drain, Gate-Source Voltage -25 V
 Gate Current 100 mA
 Lead Temperature (1/16" from case for 10 sec.) 300°C
 Storage Temperature -65 to 200°C

Operating Junction Temperature -55 to 150°C
 Power Dissipation^a 300 mW

Notes
 a. Derate 2.4 mW/°C above 25°C



SPECIFICATIONS (T _A = 25 °C UNLESS OTHERWISE NOTED)										
Parameter	Symbol	Test Conditions	Typ ^a	Limits						Unit
				2N5432		2N5433		2N5434		
				Min	Max	Min	Max	Min	Max	
Static										
Gate-Source Breakdown Voltage	V _{(BR)GSS}	I _G = -1 μA, V _{DS} = 0 V	-32	-25		-25		-25		V
Gate-Source Cutoff Voltage	V _{GS(off)}	V _{DS} = 5 V, I _D = 3 nA		-4	-10	-3	-9	-1	-4	
Saturation Drain Current ^b	I _{DSS}	V _{DS} = 15 V, V _{GS} = 0 V		150		100		30		mA
Gate Reverse Current	I _{GSS}	V _{GS} = -15 V, V _{DS} = 0 V T _A = 150 °C	-5		-200		-200		-200	pA
			-10		-200		-200		-200	nA
Gate Operating Current ^c	I _G	V _{DG} = 10 V, I _D = 10 mA	-10							pA
Drain Cutoff Current	I _{D(off)}	V _{DS} = 5 V, V _{GS} = -10 V T _A = 150 °C	10		200		200		200	
			20		200		200		200	nA
Drain-Source On-Voltage	V _{DS(on)}	V _{GS} = 0 V, I _D = 10 mA			50		70		100	mV
Drain-Source On-Resistance	r _{DS(on)}			2	5		7		10	Ω
Gate-Source Forward Voltage ^c	V _{GS(F)}	I _G = 1 mA, V _{DS} = 0 V	0.7							V
Dynamic										
Common-Source Forward Transconductance ^c	g _{fs}	V _{DS} = 5 V, I _D = 10 mA f = 1 kHz	17							mS
			600							μS
Common-Source Output Conductance ^c	g _{os}									
Drain-Source On-Resistance	r _{ds(on)}	V _{GS} = 0 V, I _D = 0 mA f = 1 kHz			5		7		10	Ω
Common-Source Input Capacitance	C _{iss}	V _{DS} = 0 V, V _{GS} = -10 V f = 1 MHz	20		30		30		30	pF
Common-Source Reverse Transfer Capacitance	C _{rss}		11		15		15		15	
Equivalent Input Noise Voltage ^c	e _n	V _{DS} = 5 V, I _D = 10 mA f = 1 kHz	3.5							nV/ √Hz
Switching										
Turn-On Time ^b	t _{d(on)}	V _{DD} = 1.5 V, V _{GS(H)} = 0 V See Switching Circuit	2		4		4		4	ns
	t _r		0.5		1		1		1	
Turn-Off Time ^b	t _{d(off)}		4		6		6		6	
	t _f		18		30		30		30	

Notes
 a. Typical values are for DESIGN AID ONLY, not guaranteed nor subject to production testing.
 b. Pulse test: PW ≤ 300 μs duty cycle ≤ 3%.
 c. This parameter not registered with JEDEC.

NIP



TYPICAL CHARACTERISTICS (T_A = 25 °C UNLESS OTHERWISE NOTED)

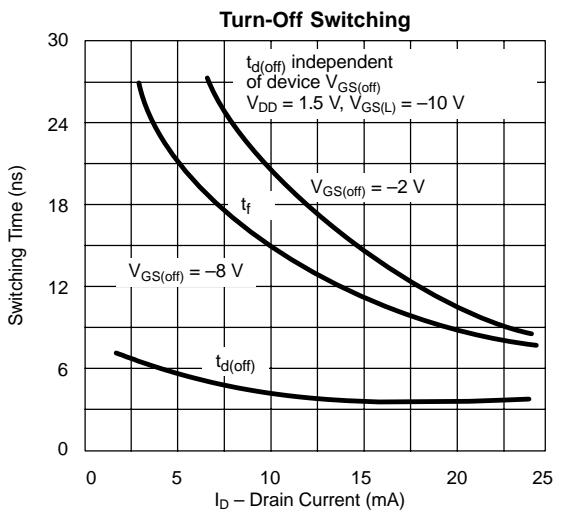
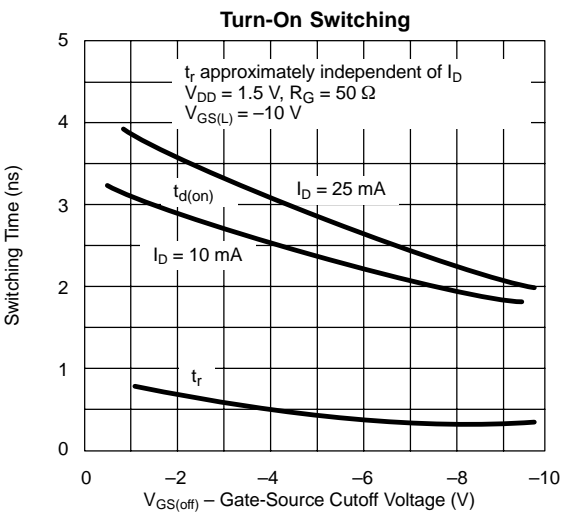
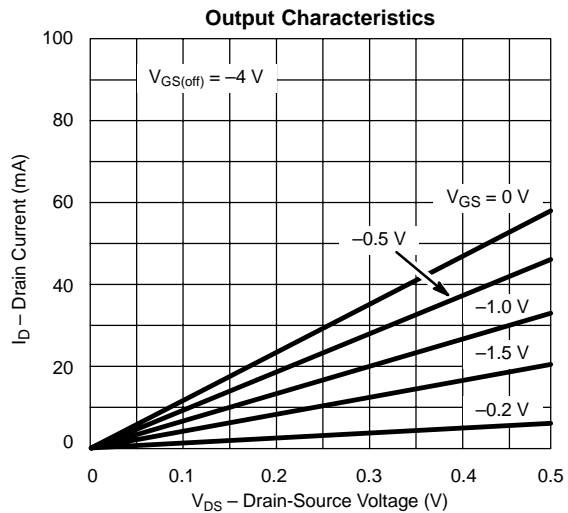
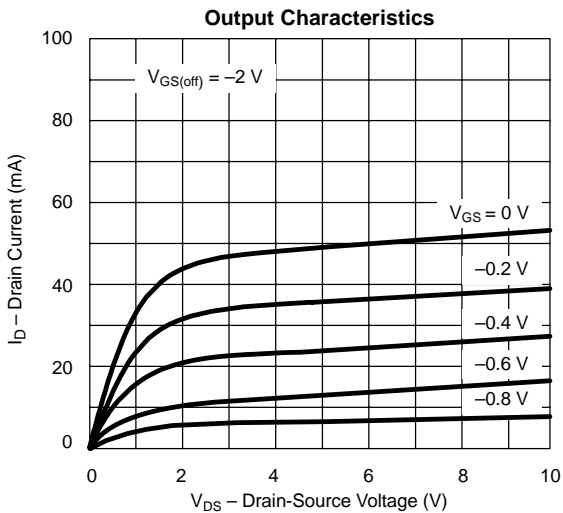
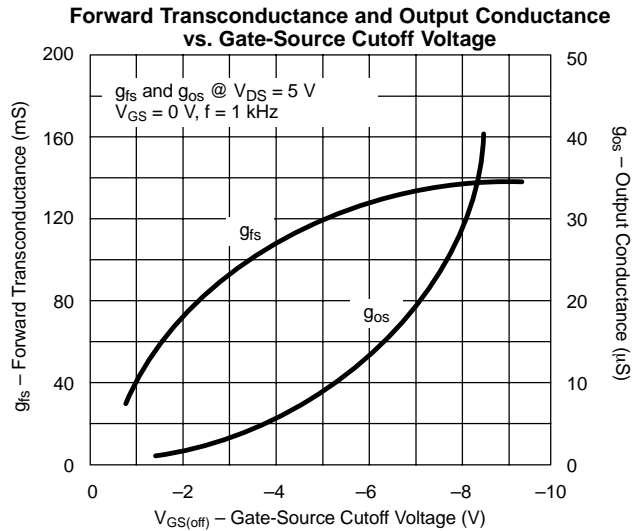
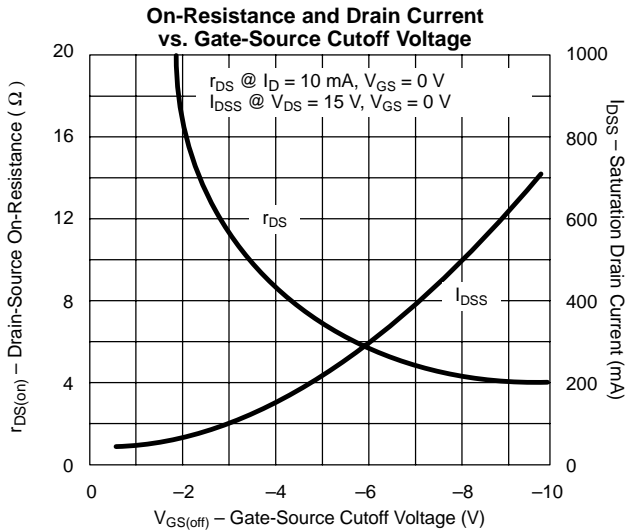

TYPICAL CHARACTERISTICS (25°C UNLESS NOTED)

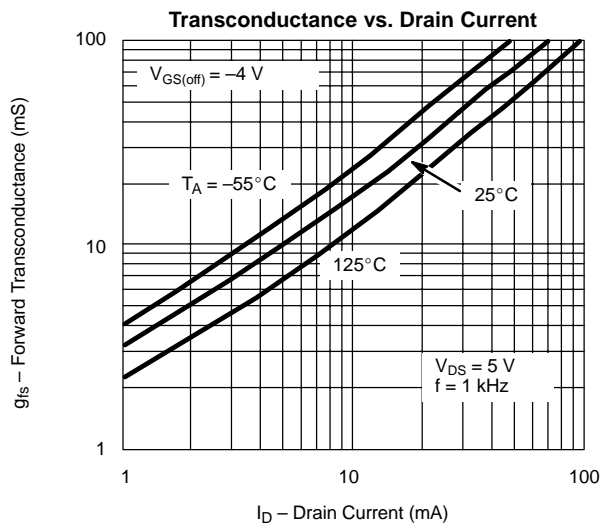
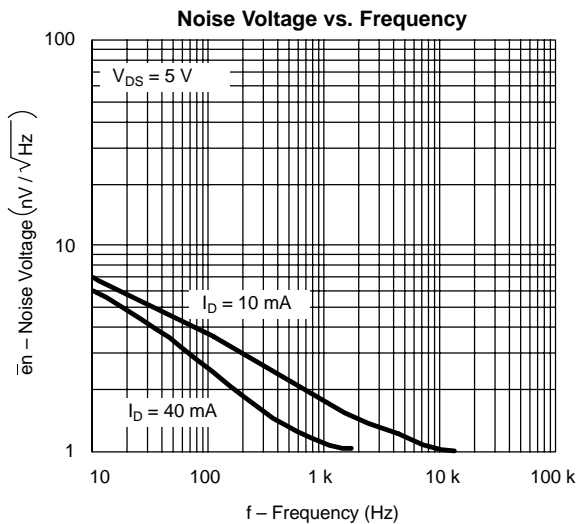
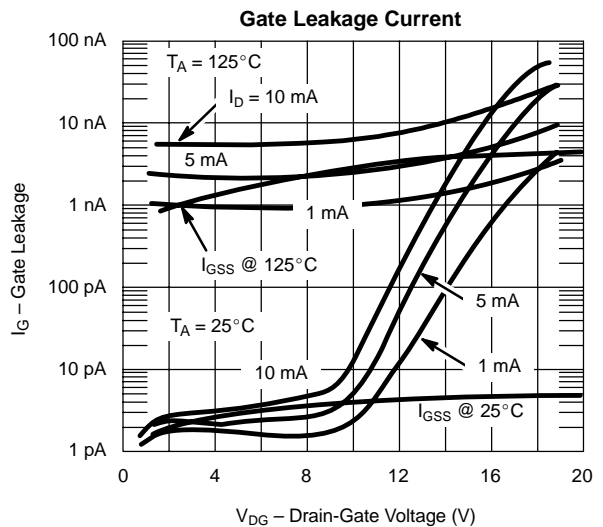
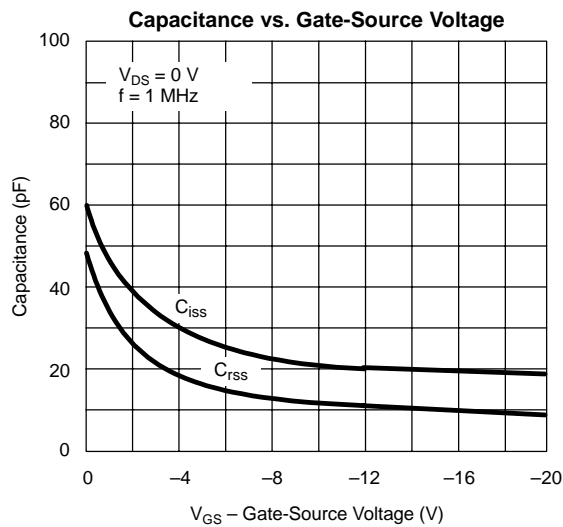
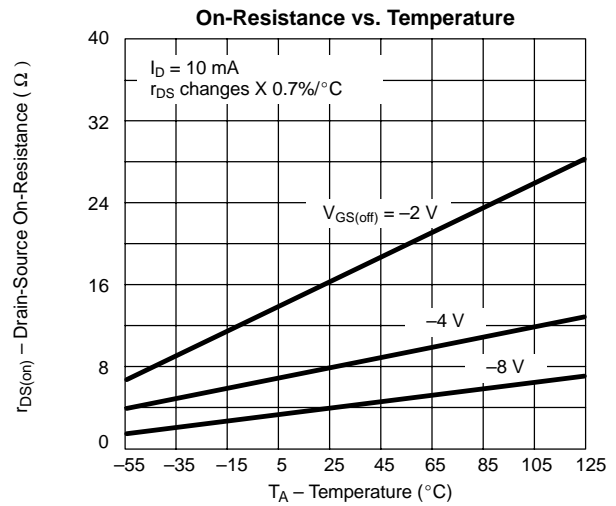
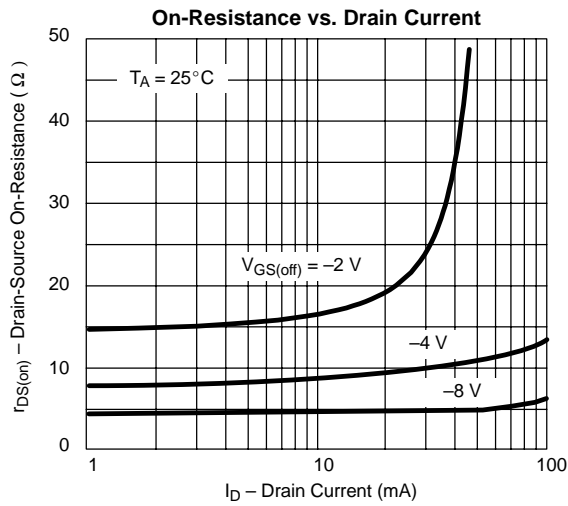



TYPICAL CHARACTERISTICS (25°C UNLESS NOTED)

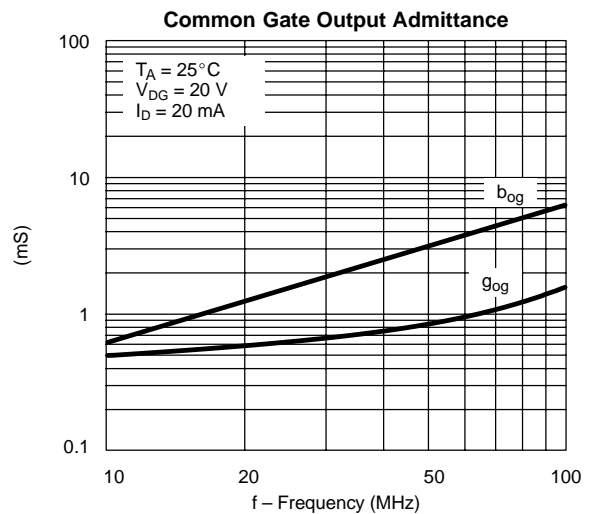
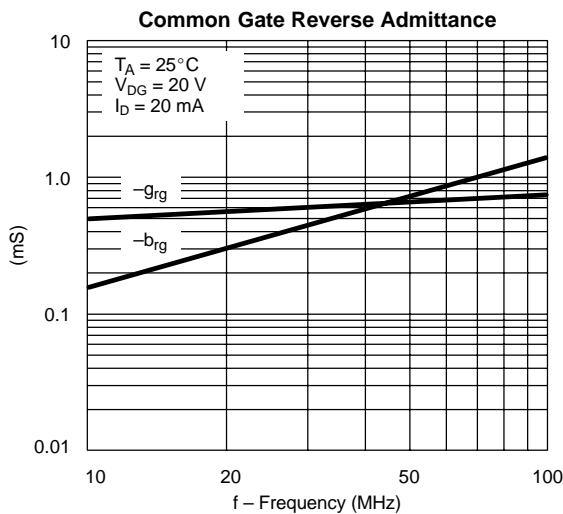
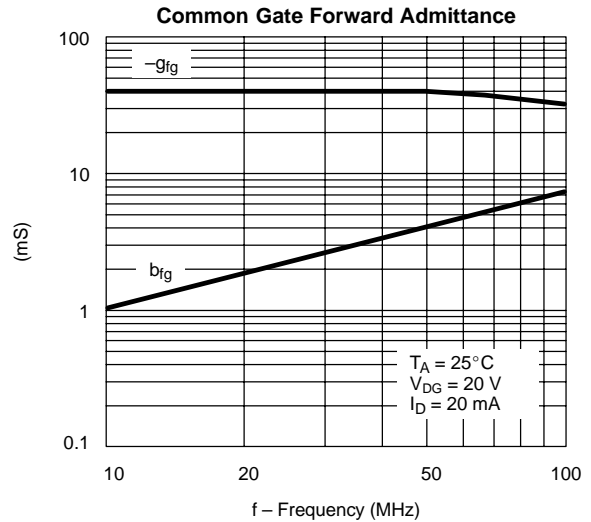
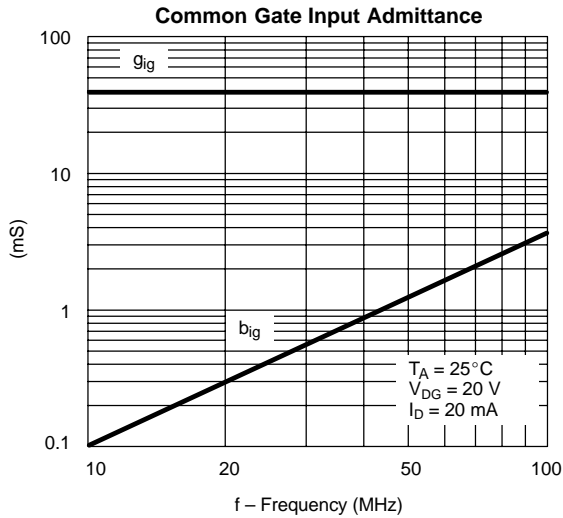

SWITCHING TIME TEST CIRCUIT			
	2N5432	2N5433	2N5434
$V_{GS(L)}$	-12 V	-12 V	-12 V
R_L^*	145 Ω	143 Ω	140 Ω
$I_{D(on)}$	10 mA	10 mA	10 mA

*Non-inductive

INPUT PULSE

Rise Time < 1 ns
 Fall Time < 1 ns
 Pulse Width 100 ns
 PRF 1 MHz

SAMPLING SCOPE

Rise Time 0.4 ns
 Input Resistance 10 M Ω
 Input Capacitance 1.5 pF

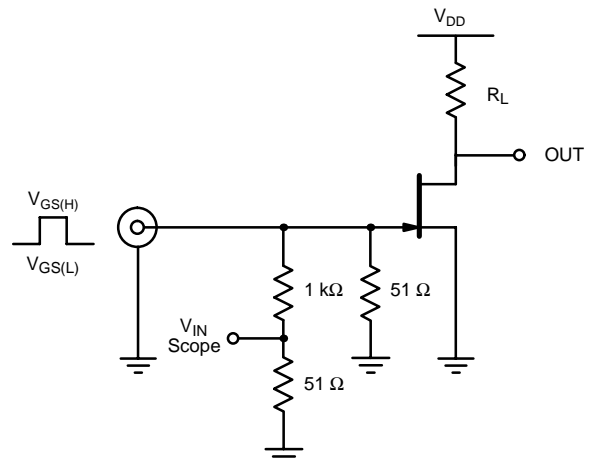

This datasheet has been download from:

www.datasheetcatalog.com

Datasheets for electronics components.